

AUTOCAD GENERATED DRAWING, DON'T CHANGE BY HAND

REV.	ECN. NO.	APPD.
A	ECN160125017	Fan Fang
B	ECN160203003	Fan Fang
C	ECN171108007	Darren Lei
D	ECN180423027	Darren Lei

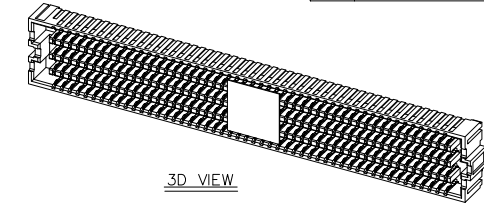
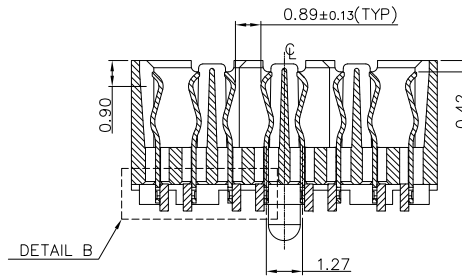
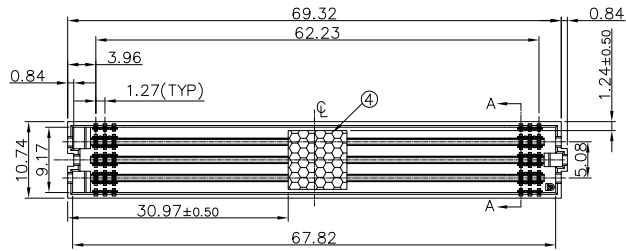

3D VIEW

SECTION A-A

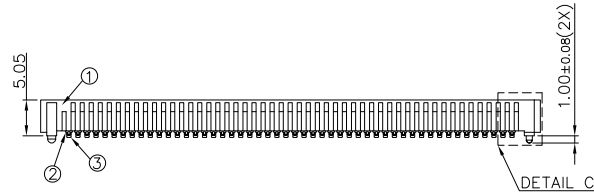

DETAIL C

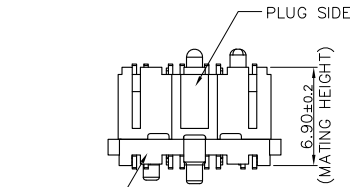

MATING CONDITION

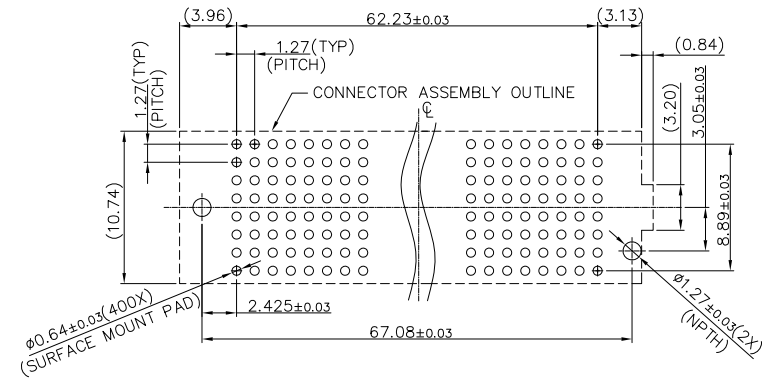

RECOMMENDED PCB LAYOUT

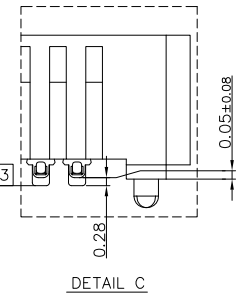
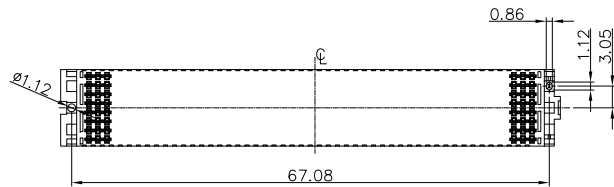

DETAIL C

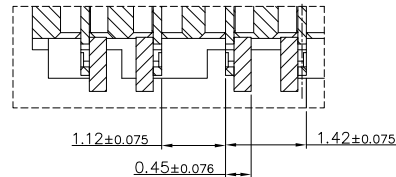

DETAIL B

PART LIST

BTBSD01-50300-1H

- ④ MYLAR
- ③ SOLDER CHARGE
- ② CONTACT
- ① HOUSING
- B: 1.27PITCH
- S: RECEPTACLE
- POS NO.
- DO: 400POS
- CONTACT AREA PLATING: 1:10u" MIN GOLD PLATING
- LEAD & HALOGEN FREE
- PACKAGE CODE 1: CARRIER TAPE
- PROFILE HEIGHT: 50: 5.05mmH

- NOTES:
- DIMENSIONS SHOULD BE INTERPRETED PER ASME Y14.5-1994.
  - THE MATING FORCE IS 18KGF MAX., THE UNMATING FORCE IS 0.23KGF MIN.
  - ENVIRONMENTAL CHARACTERISTICS:  
3-1. OPERATING TEMPERATURE: -55°C~+125°C
  - HARMFUL MATERIAL CONTROL SHOULD MEET ROHS REQUIREMENT AND DRAPHO DOCUMENT "DQSP2014"

TABLE FOR MATING CONDITION

ITEM	NAME	PART NO.	VENDER
②	REC. CONNECTOR	BTBSD01-50300-1H	Drapho
①	PLUG CONNECTOR	BT1P400*-5601H	Drapho

ITEM	DESCRIPTION	Q'TY	MATERIAL	TREATMENT	ATTACHMENT
④	MYLAR	1		SPEC: 8.25mm*8.25mm	
③	SOLDER CHARGE	400	Sn		
②	CONTACT	400	COPPER ALLOY	NICKEL UNDER PLATING; TIN PLATING ON SOLDER AREA GOLD PLATING ON CONTACT AREA	
①	HOUSING	1	THERMOPLASTIC	COLOR: BLACK	UL, 94V-0

UNITS:	GENERAL TOLERANCE	APPROVE:	PART NO.(INTENDED USE)
mm		Darren Lei	BTBSD01-50300-1H
DATE: 04/23'18	X. ±0.30 .X ±0.20 .XX ±0.15	CHECKED: Mike Wu	TITLE: CUSTOMER DRAWING FOR 1.27P 400POS RECEPTACLE
SCALE: N/A	.X* ±5.00' .X* ±3.00' .XX* ±2.00'	DRAW: Tiance Meng	DRAWING NO.: 820-0000-0256
SHEET: 1/2	MATERIAL: N/A		Highstar
REV.: D	FINISH: N/A		



REV.	ECN. NO.	APPD.

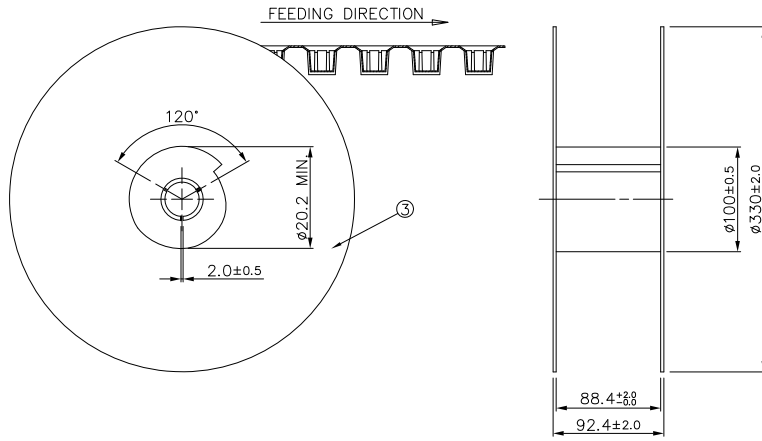

NOTES:

- 10 PITCHES CUMULATIVE TOLERANCE ON TAPE ±0.20mm.
- COVER TAPE PEELING STRENGTH: 0.13kgf MAX AT 300mm/MINUTE.

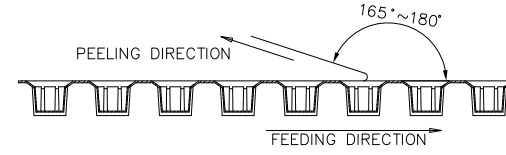

3. PACKING CAPACITY:

P/N	PCS/REEL	REEL/BOX	PCS/BOX
BTBSD01-50300-1H	300	1	300

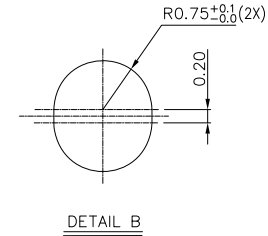
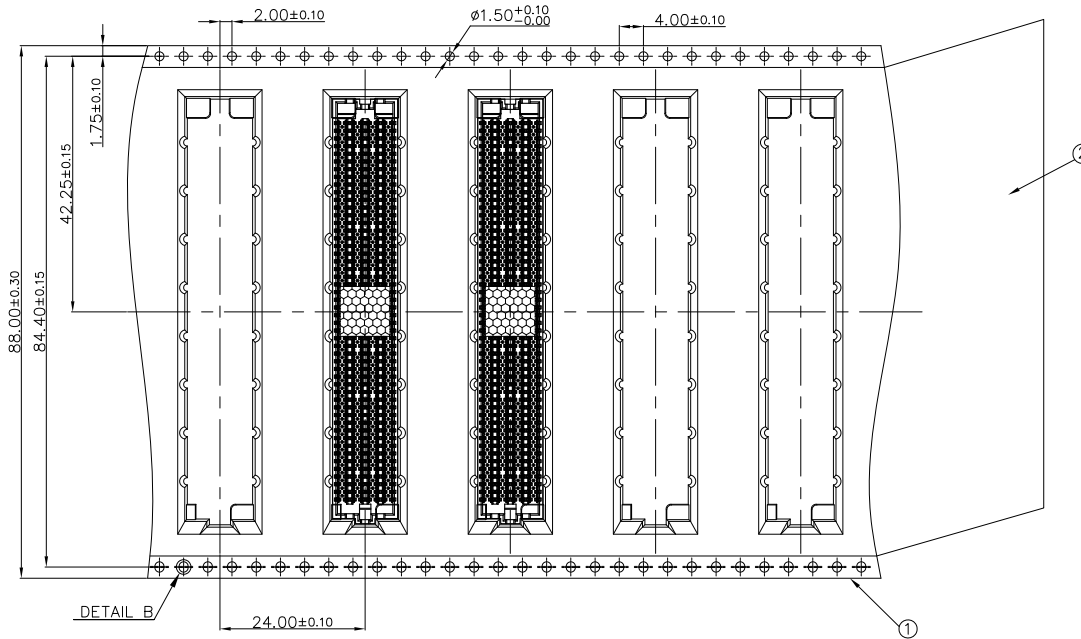

③	REEL
②	COVER TAPE
①	CARRIER TAPE
ITEM	DESCRIPTION

UNITS: mm	GENERAL TOLERANCE	APPROVE: Darren Lei	PART NO.(INTENDED USE) BTBSD01-50300-1H
DATE: 04/23'18	X: ±0.30 Y: ±0.20 SCALE: N/A	CHECKED: Mike Wu	TITLE: CUSTOMER DRAWING FOR 1.27P 400POS RECEPTACLE
SHEET: 2/2	MATERIAL: Q'TY N/A	DRAW: Tiange Meng	DRAWING NO.: 820-0000-0256
REV.: D	FINISH: N/A		
			Highstar